

Ordering Information:

A1501HD-XP - ***
1 2

1.Part NO.

2.Color:

(Blank): White

IV: Ivory

TR: Tomato

DH: Dark gray

LY: Lemon yellow

DO: Dark orange

BK: Black

GN: Green

BR: Brown

VYL: Vivid yellow

OR: Orange

BL: Blue

MG: Moss green

DPK: Dark pink

LE: Light blue

DP: Dark purple

RD: Red

YL: Yellow

VI: Purple

PK: Pink

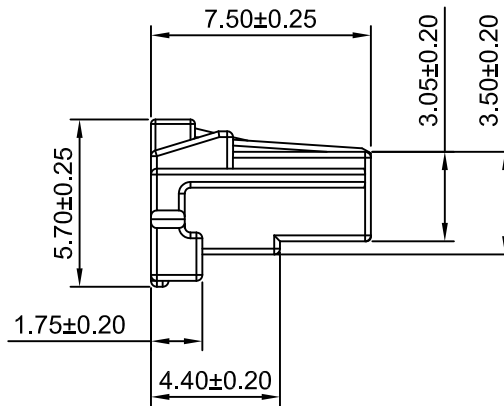
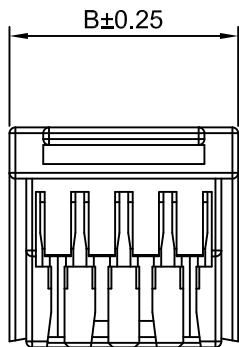
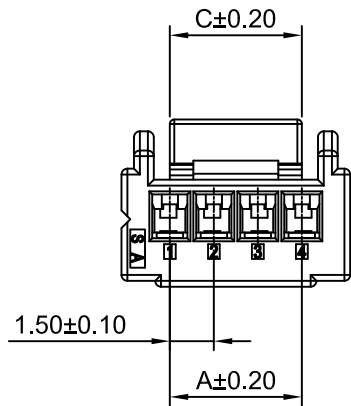
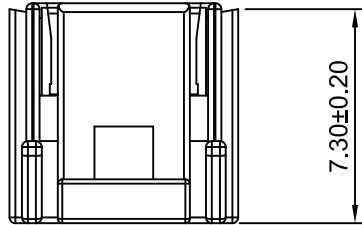
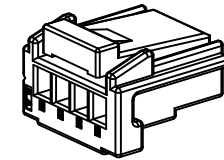

SPECIFICATIONS:

Current Rating: 2A AC,DC (AWG #24)

Voltage Rating: 100V AC,DC

Temperature Range: -40°C ~ +105°C

Contact Resistance: 20mΩ Max.

Insulation Resistance: 500MΩ Min.

Withstanding Voltage: 500V AC/minute

Material: PBT,UL94V-0

Ordering Information & Dimensions

Circuits	Dimensions(mm)			Circuits	Dimensions(mm)		
	A	B	C		A	B	C
2P	1.50	5.00	2.70	10P	13.50	16.80	9.80
3P	3.00	6.30	3.50	11P	15.00	18.30	9.80
4P	4.50	7.80	4.50	12P	16.50	19.80	9.80
5P	6.00	9.30	4.50	13P	18.00	21.30	11.30
6P	7.50	10.80	7.50	14P	19.50	22.80	11.30
7P	9.00	12.30	7.50	15P	21.00	24.30	11.30
8P	10.50	13.80	9.80	16P	22.50	25.80	11.30
9P	12.00	15.30	9.80				

CJTconn

CHANGJIANG CONNECTORS CO.,LTD.

Unit: mm
Scale: 4:1
Sheet: 1 of 2

Title: 1.50mm Pitch
Housing

Draw By: Dlankul Wan
Approved: Jack Yin

REV	DESCRIPTION	DATE	General Tolerance	PROJECT
A4	CHANGE THE MATERIAL	2019.11.25	x.xx±0.25 x.xxx±0.15	PROJECT
A3	CHANGE THE DRAWING	2019.10.10		
A2	CHANGE THE DRAWING	2019.05.27		

DRAW NO: A1501HD-XP
REV A4



2P

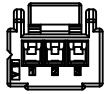

3P

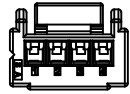

4P

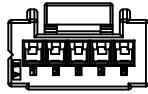

5P

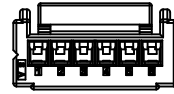

6P

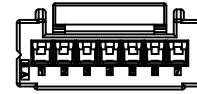

7P

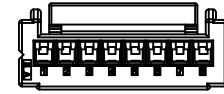

8P

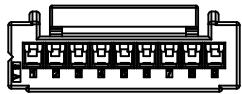

9P

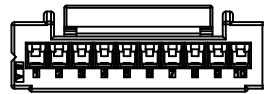

10P

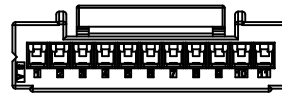

11P

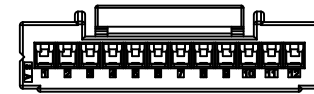

12P



13P



14P

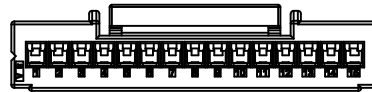

15P



16P

CJTconn CHANGJIANG CONNECTORS CO.,LTD.

Unit mm Scale 2:1 Sheet 2 of 2

Draw By: Diankui Wan Approved: Jack Yin

Title : 1.50mm Pitch Housing

REV	DESCRIPTION	DATE
A4	CHANGE THE MATERIAL	2019.11.25
A3	CHANGE THE DRAWING	2019.10.10
A2	CHANGE THE DRAWING	2019.05.27

General Tolerance
x.xx±0.25
x.xxx±0.20
x.xxxx±0.15
PROJECT

DRAW NO : A1501HD-XP REV A4